



Stainless steel Drink water Shallow well pump

This Drink water Shallow Well Pump is ideal for pumping in depths 25ft. or less. Stainless steel construction prevents rust contamination and ensures cleaner, healthier drinking water.



ANSI/NSF61&ANSI/NSF372
CERTIFICATION
FOR DRINK WATER



Performance

Drink water Shallow well pump

- 115V/ 60 Hz
- Power:1HP
- 1" suction and 1" discharge
- Maximum discharge height (head) 170feet
- Flow Rate: 1100GPH
- Maximum liquid temperature: 140 degrees F
- 10' power cord
- Pressure switch is pre-set at 30-50 PSI for automatic operation
- For wells 0 ft. - 25 ft. in depth





MATERIAL

- ▶ Stainless steel construction
- ▶ Impeller & Diffuser is glass-reinforced thermoplastic.
- ▶ Thermoplastic impeller with steel shaft
- ▶ **All of the parts and water contacts in is conform to ANSI/NSF61&ANSI/NSF372 criterion**
- ▶ **Lead-Free**

Performance & Lifetime Testing



PERFORMANCE CURVE

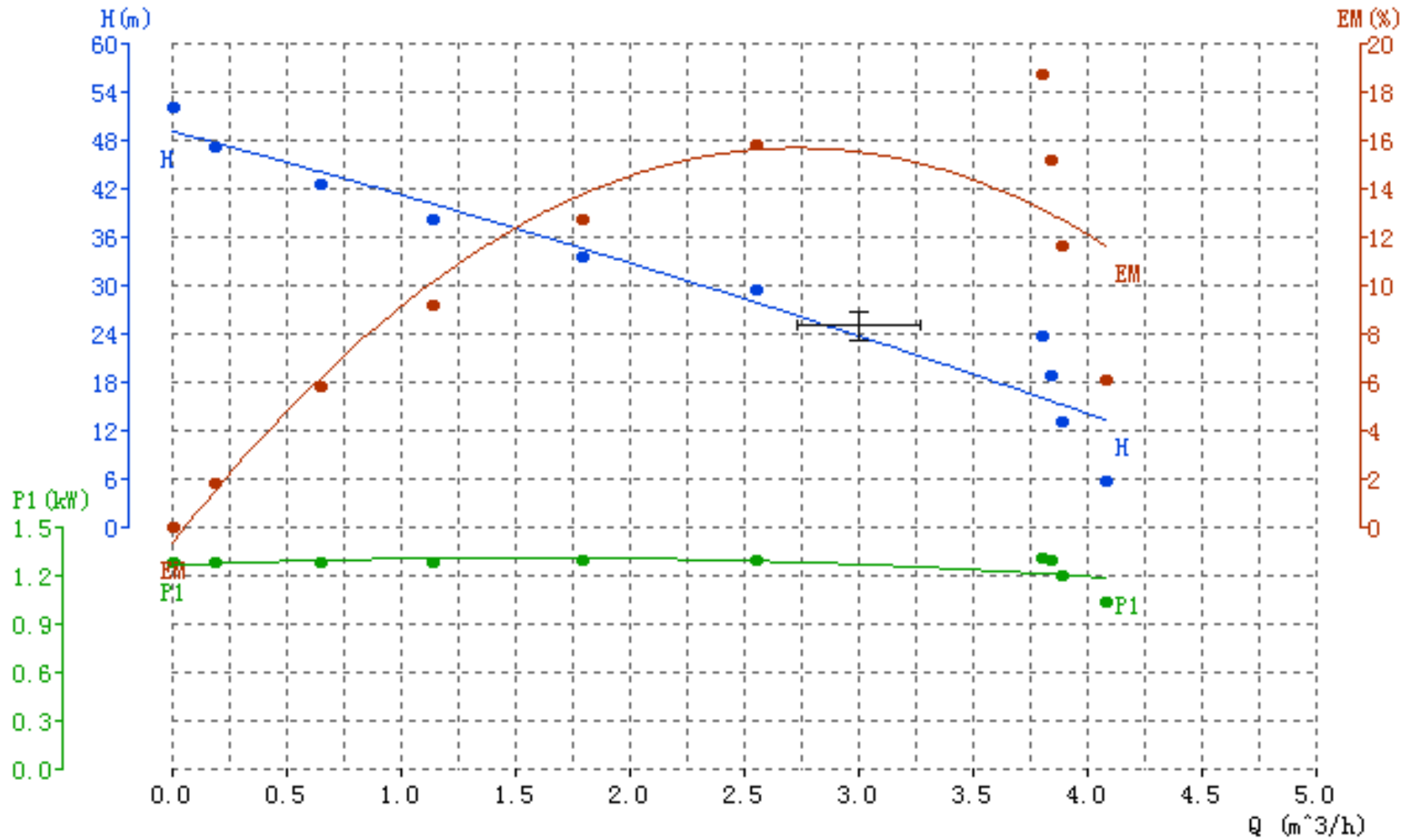

Explosive view

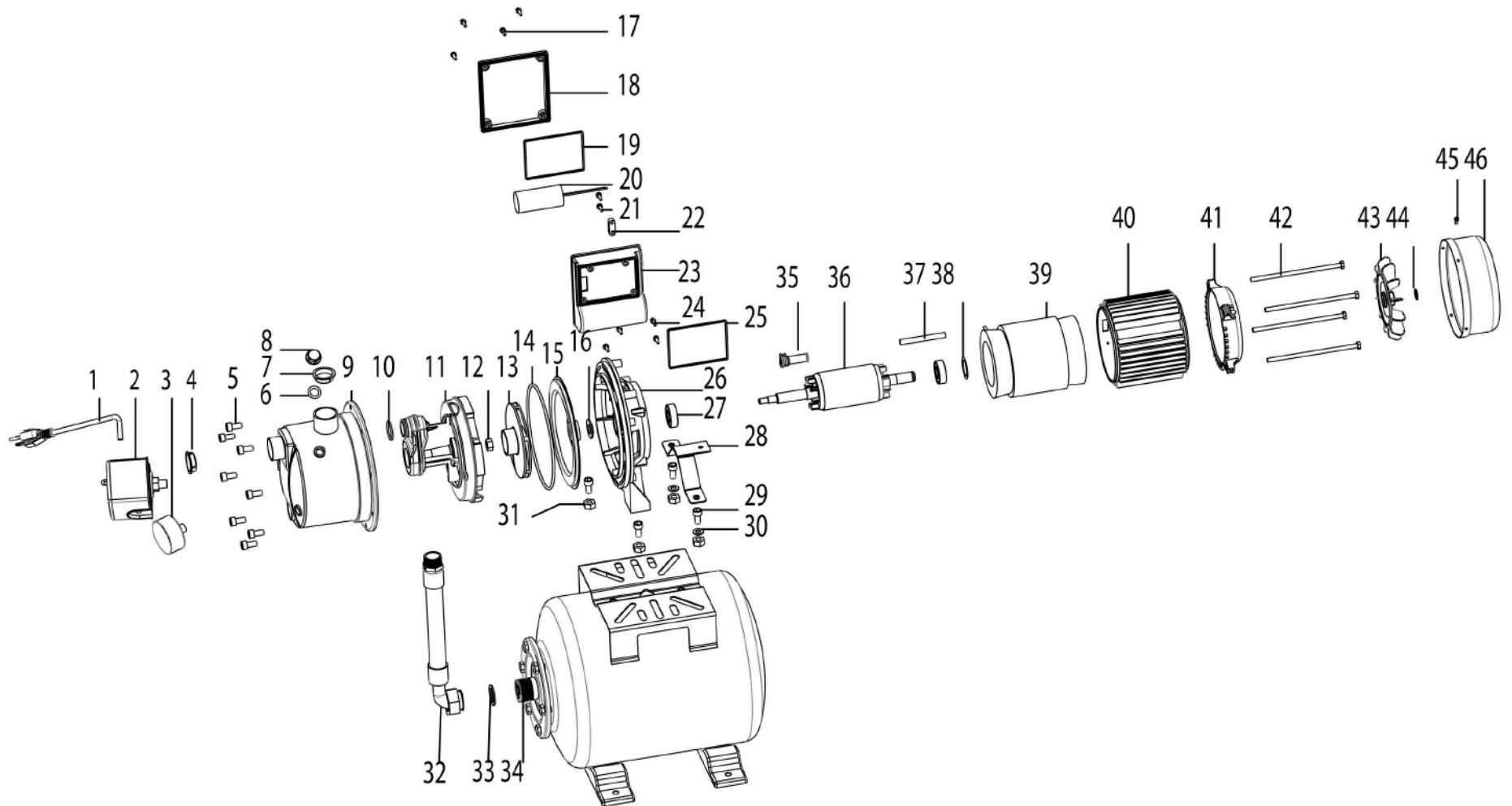



Part list



Part	Description	Qty.
1	Plug and Cable	1
2	Pressure Switch	1
3	Pressure Gauge	1
4	Dust Cover	1
5	Screw	8
6	O-Ring	1
7	Dust Cover	1
8	Screw	1
9	Pump Body	1
10	O-Ring	1
11	Guiding Object	1
12	Nut	1
13	Impeller	1
14	O-Ring	1
15	Flange	1
16	Water Proof Ring	1
17	Bolt	4
18	Terminal Box	1
19	Seal	1
20	Capacitor	1
21	Bolt	2
22	Block	1
23	Bottom Cover	1



Part	Description	Qty.
24	Bolt	4
25	Seal	1
26	Aluminum Front Cover	1
27	Ball Bearing	2
28	Support	1
29	Bolt	4
30	Gasket	2
31	Nut	4
32	Flexible Tube	1
33	Gasket	1
34	Tank	1
35	Sheath	1
36	Rotor	1
37	Cable	1
38	Gasket	1
39	Stator	1
40	Motor Box	1
41	Aluminum Cover	1
42	Bolt	4
43	Fan	1
44	Circlip	1
45	Bolt	4
46	Fan Cover	1



Production



					CONTAINER QTY		
Actual Product Picture (Please submit High Res Photo with Quote Sheet)	Description	Features and benefits, specifications, applications	MOQ (MOQ must be divisible by Master Pack qty)	Lead Time	20'	40'	40' HQ
	1/2HP Transfer Pump (Non-submersible)	1/2HP Transfer Pump;115V, 60Hz. ;Current 9.5A; Maximum Lift: 130ft, Max. Flow :1525GPH, 8ft 16AWG power cord,Discharge: 3/4"GHT Motor brush lifetime about 240hours Thermoplastic impeller with steel shaft Accessories includes : A:suction strainer 3/4 inch FPT inlet and outlet 3/4 inch GHT adapters. B: Filter	500	45	1600	2170	2170
	3/4HP Transfer Pump (Non-submersible)	3/4HP Transfer Pump;115V, 60Hz. ;Current 10A; Maximum Lift: 100ft, Max. Flow :2700GPH, 8ft 16AWG power cord,Discharge: 1"NPT Motor brush lifetime about 240hours Thermoplastic impeller with steel shaft Accessories includes : (1)1 in. NPT male thread to 1 in. male thread brass adapter, (2) 1 in. NPT male thread to 3/4 in. GHT male thread brass adapter, (2) replacement brushes, (1) 3/4 in. intake filter, (1) 1 in. intake filter	500	45	1316	1950	1950

					CONTAINER QTY		
Actual Product Picture (Please submit High Res Photo with Quote Sheet)	Description	Features and benefits, specifications, applications	MOQ (MOQ must be divisible by Master Pack qty)	Lead Time	20'	40'	40' HQ
	DC12V Transfer Utility Pumps	Current: 10A,Maximum Lift:35ft, Max flow:350GPH, Accessories:6' hose, filter, impeller, gasket	500	45	2800	6600	8000
	Transfer Utility Pump	Non-Submersible, 115V,60Hz, ,Maximum Lift:40ft, Max flow:350GPH, Accessories:6' hose, filter, impeller, gasket	500	45	2800	6600	8000

Actual Product Picture (Please submit High Res Photo with Quote Sheet)	Description	Features and benefits, specifications, applications	MOQ (MOQ must be divisible by Master Pack qty)	Lead Time	CONTAINER QTY		
					20'	40'	40' HQ
	1 HP STAINLESS STELL WELL PUMP	DRINKING WATER PUMP 1HP STAINLESS STEEL SHALLOW WELL PUMP AND TANK,115V,60HZ, MAX LIFT:116FT,1"NPT DISCHARGE PORT,950 GALLON PER HOUR MAX FLOW AT 0 FT.FOR CLEAR GROUND WATER ,30 PSI ON/50PSI PSI OFF	500	45			
	1HP CAST IRON SHALLOW WELL PUMP	DRINKING WATER PUMP 1HP CAST IRON SHALL WELL PUMP,115/230V CAPACITOR START;60HZ,Maximum Lift: 150ft, Max Flow:10.5GPM,NEMA standard single- phase motor with start/run capacitor,3450rpm,Heavy-duty cast iron construction;Includes factory pre-set 30/50psi press switch,produces up to 50 psi with automatic shut=off;Dual voltage conversion switch;Permanent spilt capacitor motor equipped with built-in	500	45	758	1250	1250

					CONTAINER QTY		
Actual Product Picture (Please submit High Res Photo with Quote Sheet)	Description	Features and benefits, specifications, applications	MOQ (MOQ must be divisible by Master Pack qty)	Lead Time	20'	40'	40' HQ
	1 HP Portable Sprinkler Pump	1 HP Portable Sprinkler Pump ,115V-60hzV;Stainless steel housing Convenient carrying handle Maximum flow: 1075 GPH (gallons per hour) Total head lift: 70 PSIG Suction head lift: 26 ft. Discharge: 3/4 in. garden hose thread	500	45	728	1300	1728
	750 GPH Drill Pump	750 GPH Drill Pump 3/4 in. connections fit standard garden hose Corrosion-resistant thermoplastic construction Works with most electric drills Self-priming up to 12 ft.	3000	45	14400	32400	36720

Actual Product Picture (Please submit High Res Photo with Quote Sheet)	Description	Features and benefits, specifications, applications	MOQ (MOQ must be divisible by Master Pack qty)	Lead Time	CONTAINER QTY		
					20'	40'	40' HQ
	Pedestal Sump Pump	<p>1/2 Hp Pedestal Sump Pump ,115V-60hzV; Maximum flow: 3780 GPH (gallons per hour) Total head lift:25 ft. Discharge: 1-1/2"NPT</p> <p>We use a six-pole motor drive, increase the base to improve stability, low working speed to reduce noise by 20%, start torque increased by 30%, avoid the transmission shaft and base sliding bearing stuck unable to start, improve the service life of the pump.</p>	500	45	720	1500	1620



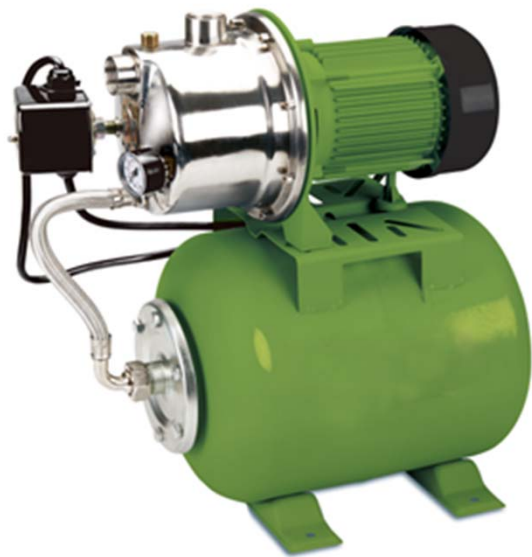

TX-50010



TX-51011



TX-51000



TX-51011



TX-50011



TX-750 GPH



TX-50001



TX-50002



TX-750 GPH



TX-5000



TX-50011



TX-51001



TX-30091